

GRINDING SPINDLE EXPERT

磨削主轴专家



北京鑫铁城精密机械有限公司
Beijing Xin Tiecheng Precision Mechanism Ltd



XINTIECHENG

鑫铁城



XINTIECHENG

鑫铁城



外圆磨削
静压电主轴

立式磨削
电主轴

平面磨削
静压主轴

内孔磨削
静压电主轴

静压转台

公司简介

北京鑫铁城精密机械有限公司是一家专业从事高精度磨削静压主轴和高速磨削电主轴及其零配件的研发设计、生产制造、销售与维修服务的环保型技术企业。

北京鑫铁城“以中高端磨削主轴产品为核心、以磨削静压和动静压电主轴精密零配件制造为支撑、以配套维修服务为特色”，通过坚持不懈的技术攻关和持之以恒吸收进口产品质量管理经验，构建了以磨削电主轴为主要产品。为满足不同类型机床的加工要求，设计研制了包括外圆磨削静压电主轴、立式磨削电主轴、平面磨削静压主轴、内孔磨削静压电主轴、静压转台数个系列精密磨削主轴及配件产品。

车间生产设备





XINTIECHENG

鑫铁城

动静压主轴



独特的结构形式：

套筒式、中间止推。

优良的使用性能：

高精度、高刚度、高效率、长使用寿命。

宽广的适用范围：

适用于高精度、高效、重载荷、重切削、宽砂轮、多砂轮等。

高精度：

主轴径向跳动、轴向窜动 $\leq 2\mu\text{m}$ ；或 $\leq 1\mu\text{m}$ 用于磨主轴系，获得卡磨件圆度 $1\mu\text{m}$ 、 $0.5\mu\text{m}$ 或小于 $0.3\mu\text{m}$ 效果。

高刚度：

径向刚度可达到 $20\text{--}50\text{kg}/1\mu\text{m}$ ；轴向刚度可达到 $50\text{--}100\text{kg}/1\mu\text{m}$

高圆度：

磨削工件内孔、外圆圆度达到 1μ 、 0.5μ 以内。

长使用寿命：

理论具有无限期使用寿命，在正常使用条件下，极少维修。高精度

高精度动静压主轴性能特点：

静压主轴精度 $\leq 0.02\text{mm}$)

动静压主轴单元具有高精度、长使用寿命等特点，广泛地适用于高精度、高效率重载荷、重切削、宽砂轮、多砂轮等领域，最新研究的科研成果在高精度的数控磨床上，将有广阔的应用前景。

动静压主轴单元系列产品：

1. 高精度外圆磨床、内圆磨床系列动静压主轴单元；
2. 高精度平面磨床系列动静压主轴单元
3. 各种型号的导轨磨、轧辊磨、轴承磨动静压主轴单元；
4. 高精度无心磨动静压主轴单元
5. 高精度数控车床用动静压主轴单元
6. 进口机床国产化配套用动静压主轴单元

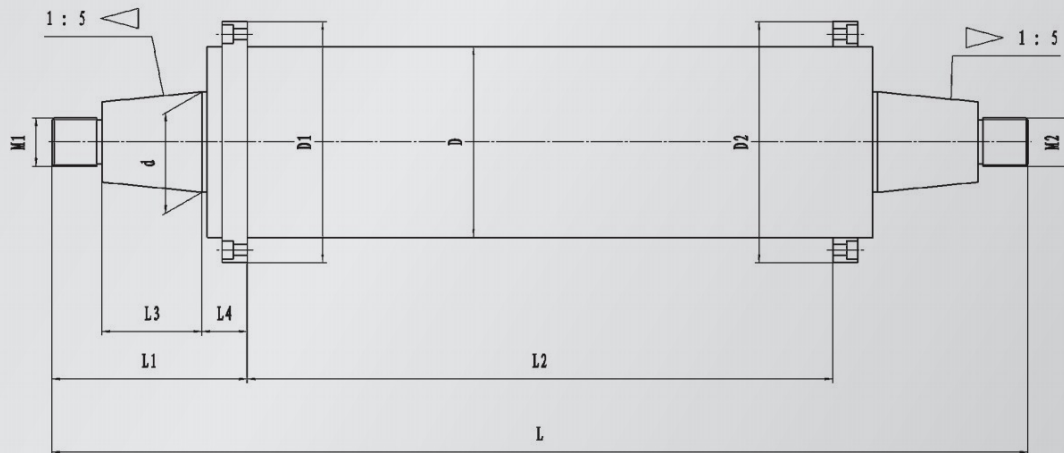

皮带驱动动静压磨削主轴

序号	型号	L	L1	L2	L3	L4	d	D	D1	D2	M1	M2	转速 n/分	电机 功 KW	砂轮尺寸 外径x内径x宽	主轴 径向 跳动 u	主轴 轴向 窜动 u	用机床	类型
1	JH-120-210-782	1252	225	782	100	45	120	210	260	260	M90X5	M90X2	750	22	1050x305x100	≤2u	≤2u	大型车轴磨床M1380	动静压
2	JH-120-210-782	1418	361.5	782	180	91.5	120	210	260	260	M68x4	M68x4	1600	30	750x305x250	≤2u	≤2u	大型车轴磨床GZ116	动静压
3	JH-120-210-782	1387	335	782	150	170	120	210	260	260	M90X2	M90X2	1700	30	750x305x250	≤2u	≤2u	大型车轴磨床M1350	动静压
4	JH-120-210-630	1098	295	630	150	75	120	210	260	260	M90X3		2000	15	900x305x150	≤2u	≤2u	M1450	动静压
5	JH-120-180-540	900	195	540	115	40	120	180	240	240	M90X2	花键	1600	18		≤2u	≤2u	导轨磨、外圆磨	动静压
6	JH-110-190-702	1315	259	765	110	86	110	190	240	240	M56X3	M56X3	1500	30	750x305x75	≤2u	≤2u	导轨磨、外圆磨	动静压
7	JH-100-200-585	960	203	585	100	43	100	200	250	250	M48X3	M48X3	1500	22		≤1u	≤1u	导轨磨、外圆磨	动静压
8	JH-100-190-556	780	249	556	100	87	100	190	250	250	M48X3	M48X3	1500	11		≤1u	≤1u	H234 控磨	动静压
9	JK-100-160-460	810	212			52	100	160	190		M42X3	花键	1500	7.5	500x203x70	≤2u	≤2u	MB1620	动静压
10	JH-100-160-660	1064	202	660	100	40	100	160	230	220	M42X3	M42X3	1500	7.5		≤2u	≤2u	M1350, MQ1350, M1450	动静压
11	JZ-90-150-560	944	214	560	80	70	90	150	194	194	M42X3	M36X2	2000	11		≤2u	≤2u	控外圆磨	动静压
12	JH-90-145-485	795	155	485	80	40	90	145	188	188	M36X1.5	M36X1.5	1500	15		≤2u	≤2u	导轨磨、外圆磨	动静压
13	JK-90-130-425	775	170	425	100	40	90	130	188	196	M42X3	M30X2		7.5		≤2u	≤2u	无心磨	动静压
14	JK-80-155-504	820	162	504	80	36	80	155	198	198	M36X2	M36X2	1500	7.5		≤2u	≤2u	M1432, M1332, M1432	动静压
15	JZ-80-180-613	870	154	613	85	27	80	180			M55X1.5	M55X1.5	1500	18		≤2u	≤2u	龙门磨	动静压
16	JH-80-135-480	790	155	480	80	40	80	135	172	172	M36X1.5	M36X1.5	1500	11		≤2u	≤2u	导轨磨、外圆磨	动静压
17	JZ-80-128-432	728	158	432	80	110	80	128	166	166	M36X3	M36X3	1500	5.5	400x203x80	≤2u	≤2u	上海M1420	动静压
18	JH-60-115-480	725	136	480	74	30	60	115	150		M33X1.5	M22X1.5	1500	7.5		≤2u	≤2u	导轨磨、外圆磨	动静压
19	JH-70-120-435	725	145	435	65	40	70	120	158	158	M36X1.5	M36X1.5	3000	7.5		≤2u	≤2u	轴承磨	动静压
20	JK-65-110-465	770	188.5	465	65	45.5	65	110	158	150	M36X3		1500	7.5	500x203x80	≤2u	≤2u	上海M1432	动静压
21	JH-60-135-480	790	155	480	80	40	60	135	172	172	M36X1.5	M36X1.5	1500	11	500x203x80	≤1u	≤1u	导轨磨	动静压
22	JZH-50-90-275	467	92	267	49	19	50	90	120	120	M24X1.5	M22X1.5	2000	3		≤2u	≤2u	M1312	动静压



XINTIECHENG
鑫铁城

动静压轴承安装

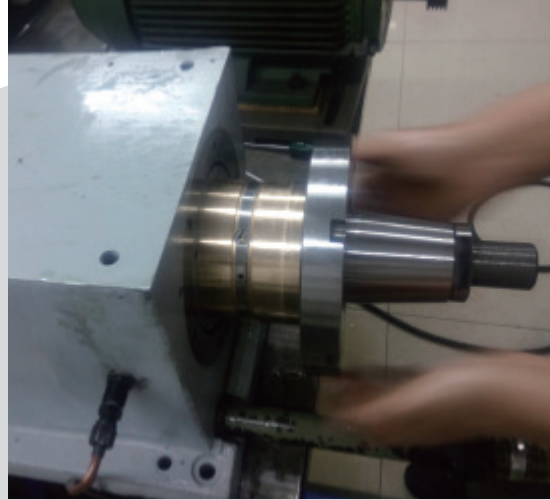
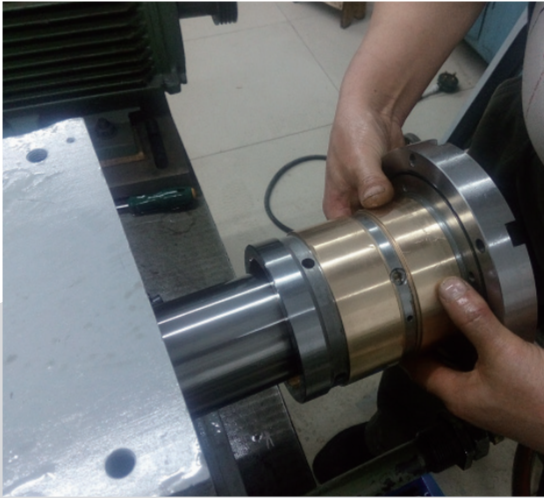

主轴运转测试

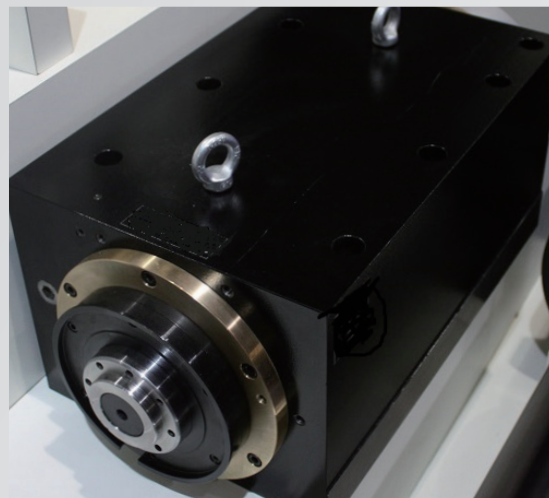

高速磨削电主轴

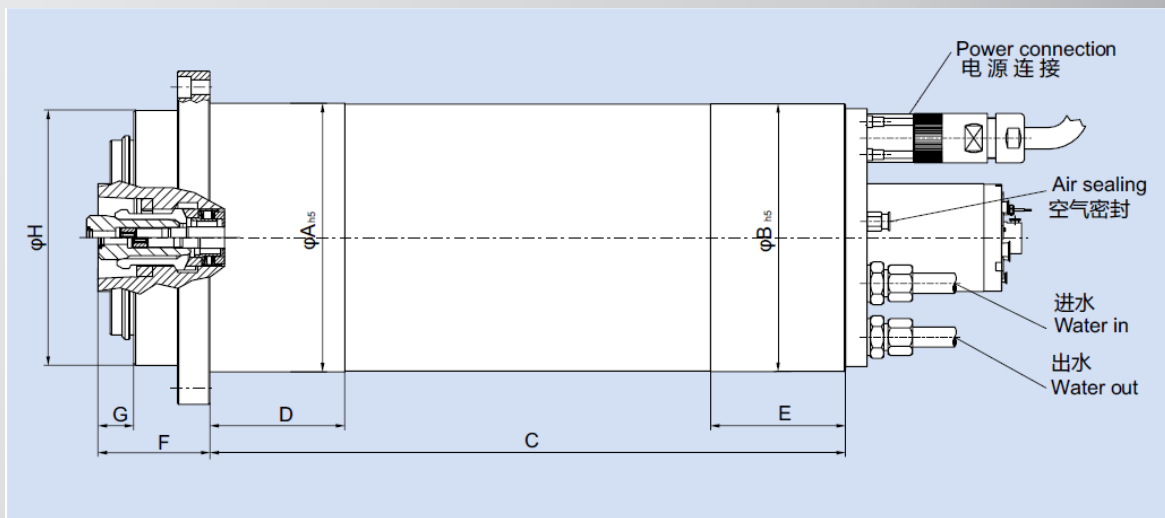

磨削电主轴采用先进的轴承结构，具有较高的精度和稳定性，此款主轴适用于高速磨削。主轴采用38crmoal 氮化 D900，高硬度保证主轴的高刚性，主轴跳动 0.002mm。



规格尺寸											
代码	H Φ	Ah5 Φ	Bhs Φ	C	D	E	F	G	接口	刚性	
										径向[N/um]	轴向[N/um]
VFS-900.000110	130	170	169	350	80	80	108	28	HSK-C63	835	139
VFS-900.000150										750	119
VFS-900.000210	185	200	199	425	100	100	113	38	HSK-C80	1195	198
VFS-900.000250										1080	170
VFS-900.000310	200	220	219	450	100	100	131	31	HSK-C80	1300	215
VFS-900.000350										1180	185
VFS-900.000410	230	250	249	550	150	150	153	28	HSK-C100	1560	257
VFS-900.000450										1420	225
VFS-900.000510	270	280	279	500	150	150	155	19	HSK-C100	1800	297
VFS-900.000550										1660	262
VFS-900.000610	285	300	299	600	150	150	204	58	HSK-C125	1970	325
VFS-900.000650										1820	284
VFS-900.000710	295	320	319	700	150	150	210	45	HSK-C125	2070	340
VFS-900.000750										1900	297
VFS-900.000810	340	350	349	850	150	150	245	58	HSK-C125	2280	375
VFS-900.000850										2100	325
VFS-900.000910	400	400	399	850	150	150	280	72	HSK-C160	2490	405
VFS-900.000950										2280	350

电机数据							
代码	功率kw	转速rpm	最大转速rpm	电压V	电流A	极数	力矩(Nm)
VFS-910.000110	20	8.000	8.500	400	53	6	24
VFS-910.000150			11.600				
VFS-910.000210	16	4000	6.500	400	45	6	38
VFS-910.000250			8.200				
VFS-910.000310	11	1500	5.500	400	46	8	70
VFS-910.000350			7.500				
VFS-910.000410	19.5	1500	4.500	400	60	8	124
VFS-910.000450			5.800				
VFS-910.000510	28.5	1500	3.700	400	94	8	181
VFS-910.000550			4.700				
VFS-910.000610	45	1500	3.500	400	135	8	287
VFS-910.000650			4.500				
VFS-910.000710	50	1500	3.200	400	200	8	318
VFS-910.000750			4.100				
VFS-910.000810	75	1500	2.600	400	151	6	478
VFS-910.000850			3.600				
VFS-910.000910	120	1500	2.300	400	247	8	764
VFS-910.000950			3.000				

立式磨床电主轴

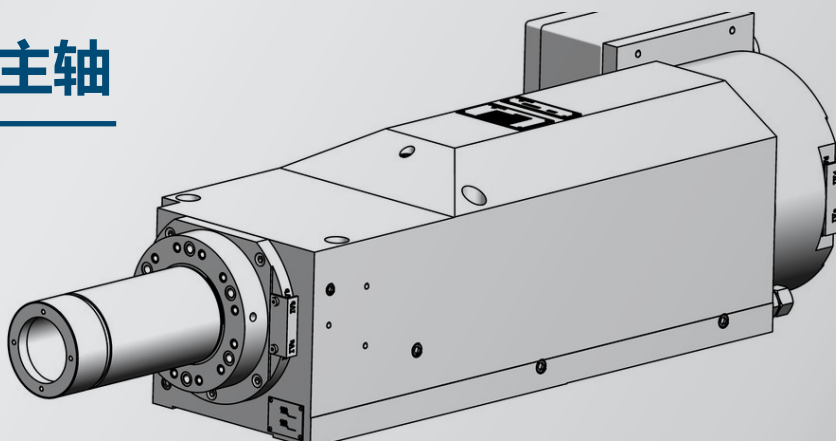

主轴图

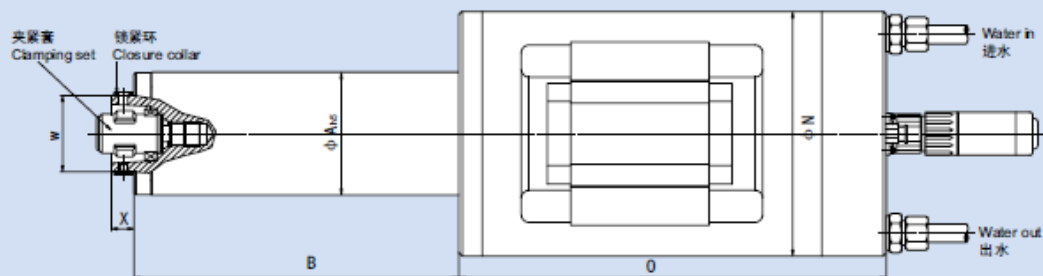

规格尺寸

代码	A/5 Φ	B	接口	N Φ	O	W	X	刚性		轴承	
								径向 [N/um]	轴向 [N/um]	前端	后端
VFS-810.000001	40	180	HSK-C32	135	205	32	10	161	28.4	4	2
VFS-810.000010	50	250	HSK-C32	135	205	32	10	166	29.1		
VFS-810.000020	60	250	HSK-C40	140	243	40	12	244	42		
VFS-810.000030	80	300	HSK-C50	160	278	50	14.5	332	56.5		
VFS-810.000040	100	315	HSK-C63	200	330	63	25	445	75		
VFS-810.000050	120	350	HSK-C63	220	285	63	25	540	89		

电机数据

电机数据 代码	功率(KW)	转速rpm	电压(v)	电流(A)	频率(Hz)	极数	力矩(Nm)
VFS-810.000001	3.0	17.600	400	7	600	4	1.63
VFS-810.000010	3.0	17.600		7	600		1.63
VFS-810.000020	8.0	17.600		18	600		4.34
VFS-810.000030	11.0	11.700		22	400		8.97
VFS-810.000040	15.0	10.800		35	367		13.26
VFS-810.000050	15.0	8.850		33	300		16.18



内圆磨削高速电主轴

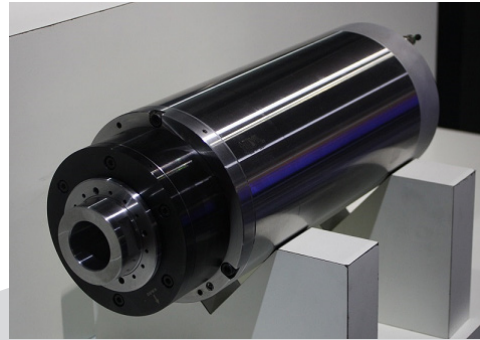

电机数据							
代码	功率(KW)	转速rpm	电压(v)	电流(A)	频率(Hz)	极数	力矩(Nm)
VFS-840.000020	1.4	40,000	400	3.5	1000	4	0.22
VFS-840.000220							
VFS-840.000030	2.3	29,000	400	5.8	1000	4	0.75
VFS-840.000031							
VFS-840.000230							
VFS-840.000040	7.2	29,600	400	18	1000	4	2.32
VFS-840.000240							
VFS-840.000241							
VFS-840.000250	13	24,700	400	28	834	4	5.00

A型规格尺寸														
代码	Ah5 Φ	B Φ	F	刀夹	C	D	E	G	ΦW	X	刚性		轴承	
											径向[N/um]	轴向[N/um]	前端	后端
VFS-840.000220	60	59.5	205	HSK-C25	129	18	58	214	25	9	/	/	2	3
VFS-840.000230	80	79	255	HSK-C25	189.5	26	39.5	264.5	25	9.5	34.5	200	4	1
VFS-840.000240	100	99	325	HSK-C40	260	30	35	340	40	15	/	/	2	2
VFS-840.000241	100	99	325	HSK-C50	260	30	35	342	50	17	/	/	2	2
VFS-840.000250	120	119.5	375	HSK-C50	310	25	40	375	50	17	/	/	2	2

高速静压电主轴

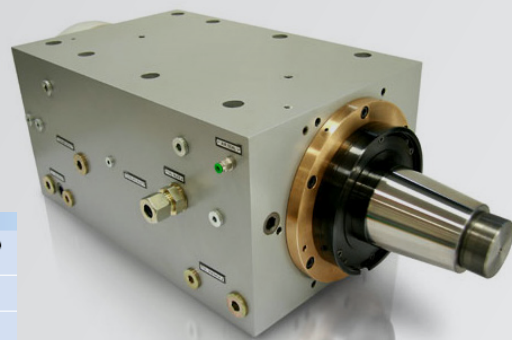

电机数据							
电机数据	功率kw	转速rpm	最大转速rpm	电压V	电流A	极数	力矩(Nm)
VFS-930.000110	20	8,000	8,500	400	53	6	24
VFS-930.000150			11,600				
VFS-930.000210	16	4,000	6,500	400	45	6	38
VFS-930.000250			8,200				
VFS-930.000310	11	1500	5,500	400	46	8	70
VFS-930.000350			7,500				
VFS-930.000410	19.5	1500	4,500	400	60	8	124
VFS-930.000450			5,800				
VFS-930.000510	28.5	1500	3,700	400	94	8	181
VFS-930.000550			4,700				
VFS-930.000610	45	1500	3,500	400	135	8	287
VFS-930.000650			4,500				
VFS-930.000710	50	1500	3,200	400	200	8	318
VFS-930.000750			4,100				
VFS-930.000810	75	1500	2,600	400	151	6	478
VFS-930.000850			3,600				
VFS-930.000910	120	1500	2,300	400	247	8	764
VFS-930.000950			3,000				

皮带驱动滚动轴承磨削主轴

B型主轴图

B型规格尺寸

代码	Ah5 Φ	B	C	D	E	F	G1	G2	H	I Φ	Kh6 Φ	L	M1	M2	SW	类型	转速	刚性		轴承	
																		径向 [N/um]	轴向 [N/um]	前端	后端
VFS-600.000040	100	250	230	14	4	12	18	45	10	16.5	48	64	M30×1.5	M16×1.5	41	B	10000	54.5	327	2	2
VFS-600.000041	100	315	295	14	4	12	18	45	10	16.5	48	64	M30×1.5	M16×1.5	41	B	10000	109.5	650	4	2
VFS-600.000042		400	380																		
VFS-600.000044		482	462																		
VFS-600.000043		630	610																		
VFS-600.000045		900	880																		
VFS-600.000050	120	250	228	15	4	13	20	45	10	16.5	52	70	M30×1.5	M16×1.5	46	B	8000	64	383	2	2
VFS-600.000051	120	315	293	15	4	13	20	45	10	16.5	52	70	M30×1.5	M16×1.5	46	B	8000	154	890	4	2
VFS-600.000054		450	428																		
VFS-600.000052		500	478																		
VFS-600.000053		630	608																		
VFS-600.000060	140	350	324	15	5	13	20	45	10	16.5	58	80	M35×1.5	M16×1.5	50	B	7000	148	880	4	2
VFS-600.000064		400	374																		
VFS-600.000061		500	474																		
VFS-600.000062		630	604																		
VFS-600.000063		800	774																		
VFS-600.000070	160	400	372	20	5	18	22	45	10	16.5	72	100	M40×1.5	M16×1.5	60	B	6000	160	960	4	2
VFS-600.000071		630	602																		
VFS-600.000072		800	772																		
VFS-600.000084	200	400	370	24	5	22	24	45	10	16.5	88	115	M50×1.5	M16×1.5	75	B	4500	227	1350	4	2
VFS-600.000080		500	470																		
VFS-600.000081		630	600																		
VFS-600.000082		800	770																		
VFS-600.000083		1000	970																		

北京鑫铁城精密机械有限公司

Beijing Xin Tiecheng Precision Mechanism Ltd

地址：北京市大兴区天宫院街道矿林路 2 号

TEL：18701348686 传真：010-62710502